

Drop-In Drop-in refrigerated well with refrigerated display, compact - 2GN

ITEM # _____

MODEL # _____

NAME # _____

SIS # _____

AIA # _____

341076 (D19C2)

 Drop-in refrigerated well
 with refrigerated display,
 compact (2 GN container
 capacity)

maximum hygiene of the food. Includes 2 adjustable shelves composed of two grids each. The shelves can be adjusted in height to allocate different items. Wells in 304 AISI stainless steel with rounded corners to facilitate cleaning operations. The well is also equipped with a drain hole. High-density expanded polyurethane foam with cyclopentane guarantees excellent well insulation to reduce energy dispersion. R290 refrigerant gas (GWP=3) to reduce environmental impact and increase cooling efficiency.

Short Form Specification

Item No. _____

Designed to be positioned in flush installation providing improved cleanability and suitable for modern design installations. Designed to serve: Plates on the shelves and food in GN containers or food on plates/packages or bottles and cans thanks to adjustable bottom well. Suitable for GN 1/1 containers with a maximum height of 200 mm. Food introduced at the correct temperature maintains its core temperature according to Afnor Standards. Automatic defrosting guarantees evaporators clearance and efficient well cooling. Digital control with temperature display with precise adjustment (0,1°C). Fully compliant HACCP digital controls include visible alarms. The unit is composed of two refrigeration systems: a static cooled well on the bottom and evaporator with fan on the top. Bottom well is designed to serve the food in GN containers or bottles and cans. Short sides and the top are in double glazed low emission glass (18 mm thick) to improve insulation avoiding formation of the condensation and reducing energy consumption. The display is illuminated by inside LED light under each glass shelf that emphasizes the cold food colors. The temperature uniformity is guaranteed by fans and an high surface evaporator placed at the top of the unit. The configuration allows a compact foodprint and excellent preservation performances. Plexiglass display case with lift-up doors on both sides to ensure

APPROVAL: _____

Main Features

- Designed to be positioned in flush installation providing improved cleanability and suitable for modern design installations.
- Precise temperature control and setting at 0,1°C .
- As standard the product comes with digitally controlled thermostat which is in line of HACCP norms and provides visual alarm as a warning of the increasing or decreasing temperatures.
- Food introduced at the correct temperature maintains its core temperature according to Afnor Standards.
- Automatic defrosting guarantees evaporators clearance and efficient well cooling.
- Remote version is available.
- Suitable for GN 1/1 containers with a maximum height of 200 mm.
- Available drop-in dimensions: 2, 3, 4 GN.
- The unit is composed of two refrigeration systems: a static cooled well on the bottom and evaporator with fan on the top.
- Bottom well is designed to serve the food in GN containers or bottles and cans.
- The temperature uniformity is guaranteed by fans and an high surface evaporator placed at the top of the unit.
- The configuration allows a compact footprint and excellent preservation performances.
- Plexiglass display case with lift-up doors on both sides to ensure maximum hygiene of the food.
- Includes 2 adjustable shelves composed of two grids each. The shelves can be adjusted in height to allocate different items.
- CB and CE certified by a third party notified body.
- The display is illuminated by inside LED light under each shelf that emphasizes the cold food colors.

Construction

- Electronic control with temperature display.
- Well bottom is inclined to facilitate water drainage.
- Well in 304 AISI stainless steel with rounded corners to facilitate cleaning operations. The well is also equipped with a drain hole.
- IPx2 water protection.

Sustainability



- Hydrocarbon refrigerant gas R290 for the lowest environmental impact (GWP=3) - CFC and HCFC free.
- High-density expanded polyurethane foam with cyclopentane guarantees excellent well insulation to reduce energy dispersion.
- Short sides and the top are in double glazed low emission glass (18 mm thick) to improve insulation avoiding formation of the condensation and reducing energy consumption.

Rear side

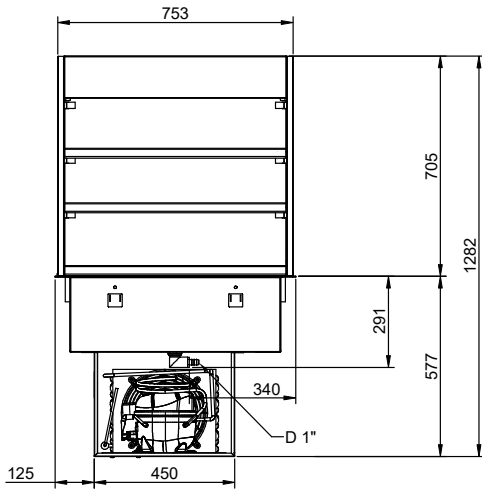

Side

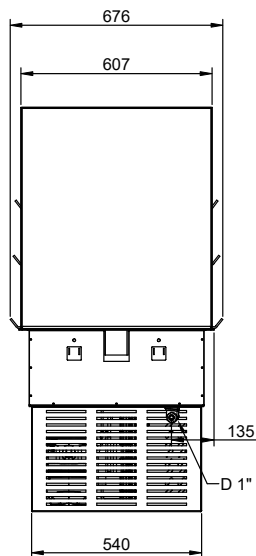

D = Drain
 EI = Electrical inlet (power)

Top

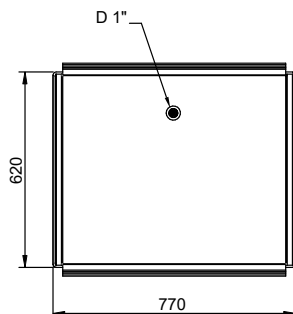

Electric

Supply voltage:

341076 (D19C2) 220-240 V/1N ph/50 Hz

Electrical power max.:

1 kW

Water:

Water drain outlet size:

1"

Drain line size:

1"

Key Information:

External dimensions, Width:	770 mm
External dimensions, Depth:	620 mm
External dimensions, Height:	1230 mm
Net weight:	125.5 kg
Shipping weight:	136 kg
Shipping height:	1350 mm
Shipping width:	660 mm
Shipping depth:	800 mm
Shipping volume:	0.71 m ³
Set temperature:	+4 / +8 °C

Refrigeration Data

Refrigerant type: R290

Sustainability

Noise level: 61 dBA

Drop-In
 Drop-in refrigerated well with refrigerated display, compact - 2GN

The company reserves the right to make modifications to the products without prior notice. All information correct at time of printing.

2024.07.17

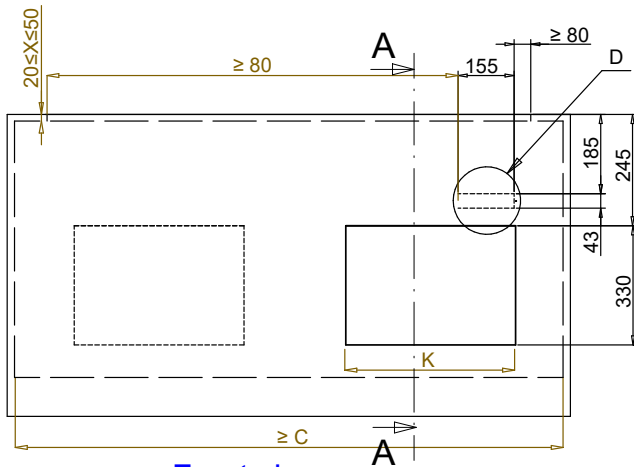

Front view
Scala: 1:10

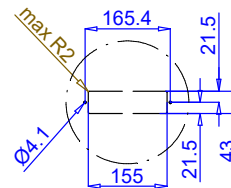

Dettaglio D
Scala 1:7

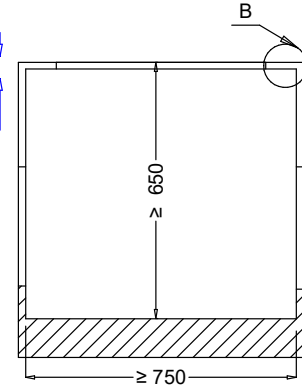

Section Cut A-A
Scala: 1:10

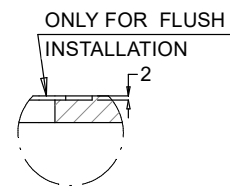

Dettaglio B
Scala 1:2

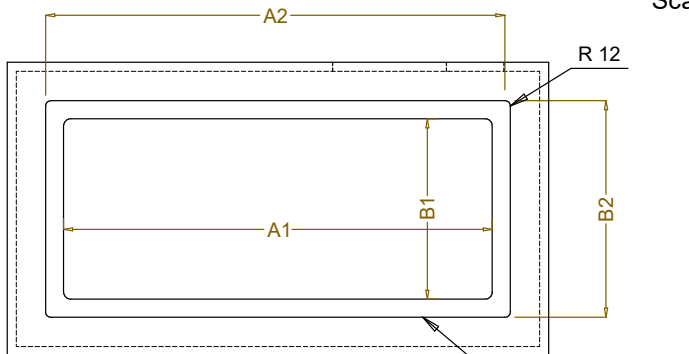

Top view
Scala: 1:10

CAPACITY	CUTOUT		LOWERING FOR FLUSH INSTALLATION		C	K
	A1	B1	A2	B2		
2GN	700		774		880	470
3GN	1030	580	1104	624	1200	730
4GN	1350		1424		1530	

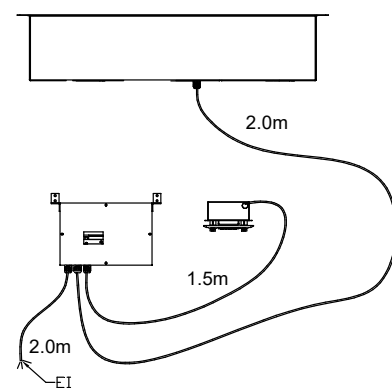
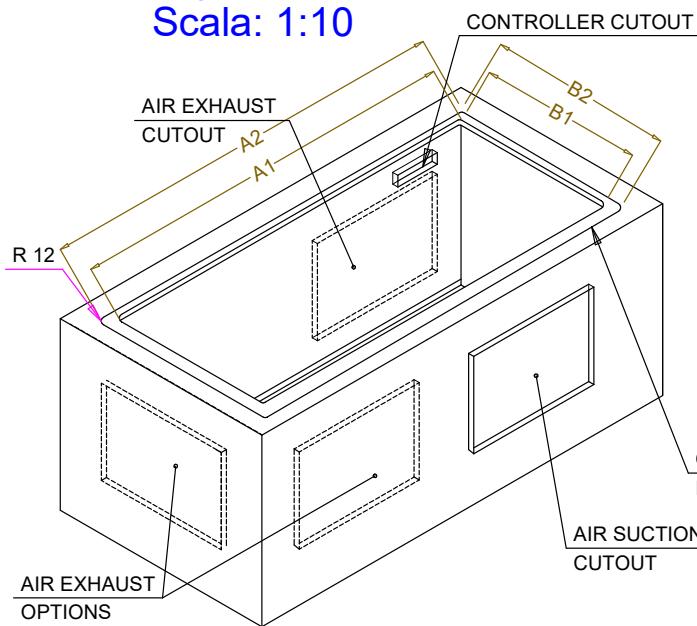

595T01U00 - COLD COMPACT DISPLAY